







MADISON Three-hole basin mixer with pop-up waste - Brushed Durabronss (23kt Gold)

MADISON

20 700 360



- 135mm projection
 - fixed spout
 - circular, air-enriched flow
 - height of mixer 72 mm
 - height up to aerator 40 mm
 - hole diameter valve 32 mm
 - hole diameter spout 35 mm
 - without rosette
 - 2x 1/2" x 1/2" high pressure hose
 - max. flow 7 l/min
 - lead-free
 - This product can help a building meet the requirements of Green Building Rating Systems, e.g. LEED®, BREEAM®, DGNB
- Only suitable for basins with an overflow.

	Brushed Durabronss (23kt Gold)	20 700 360-28
	Chrome	20 700 360-00
	Brushed Platinum	20 700 360-06
	Platinum	20 700 360-08
	Durabronss (23kt Gold)	20 700 360-09
	Brushed Dark Platinum	20 700 360-99

Recommended miscellaneous



High pressure hoses - 12 506 970 90
 • 2x 3/8" x 1/2" x 500mm high pressure hose

20 700 360
mm [inches]

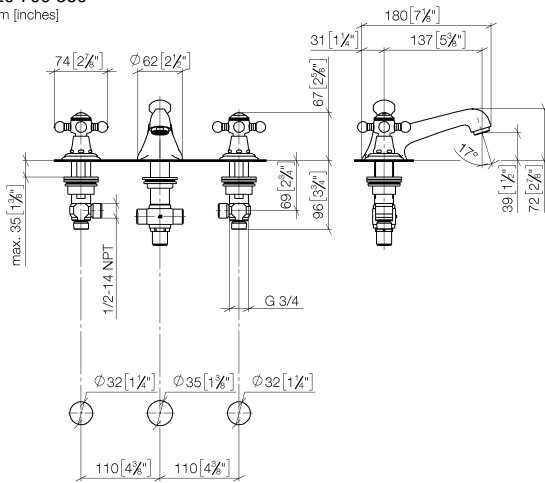

Flow rate chart

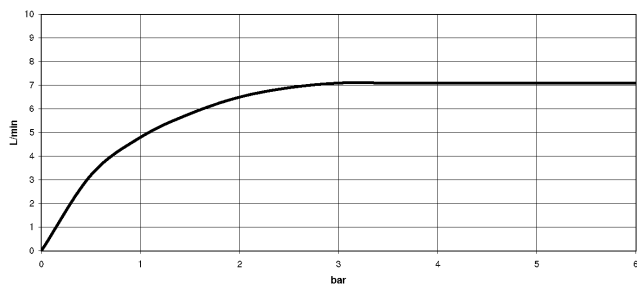

Certificates

GDV_0400288. ETA_17861. WRAS_1512009. LGA_8027.

20 700 360

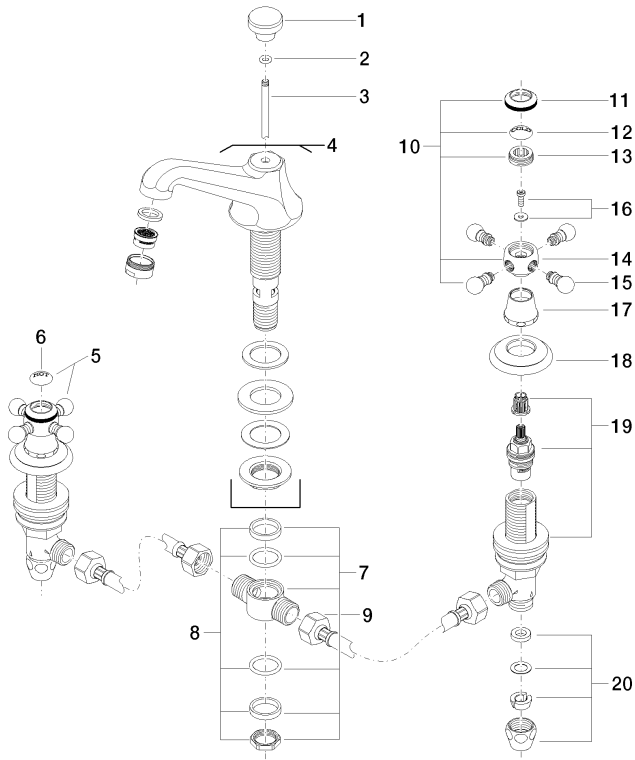

21 ————— Ablaufgarnitur 04.11.01.001.00.FP